

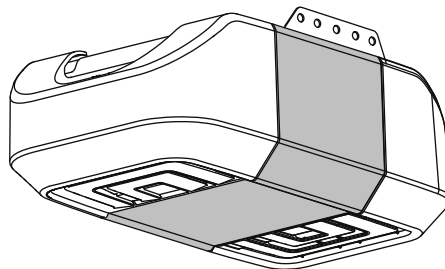

PREMIUM Series Belt Drive Garage Door Opener

Model 8355RGD - 1/2 hp

FOR RESIDENTIAL USE ONLY



- Please read this manual and the enclosed safety materials carefully!
- Fasten the manual near the garage door after installation.
- The door **WILL NOT CLOSE** unless the Protector System® is connected and properly aligned.
- Periodic checks of the garage door opener are required to ensure safe operation.
- The model number label is located on the front panel of your garage door opener.
- This garage door opener is **ONLY** compatible with MyQ® and Security+ 2.0™ accessories.
- **ONLY** enable the Timer-to-Close* or MyQ® remote operation feature* when the garage door opener is installed on a sectional door. (*Not available on all models)

NOTE: If you are installing the garage door opener on a one-piece door, visit www.liftmaster.com for installation instructions.

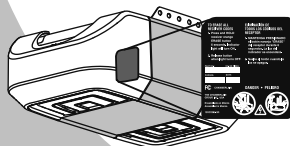

Write down the following information for future reference:

Serial Number:

Date of Purchase:

 / /

CONTENTS

Preparation	2-3
Assembly	4-5
Installation	6-13
Install the Door Control	14-16
Install the Protector System®	17-20
Power	21-22
Adjustments	23-25
Operation	26
Features	27
Door Control	28-29
Remote Control	30-31
To Erase the Memory	31
To Open the Door Manually	32
Maintenance	32
Troubleshooting	33-34
Accessories	35
Warranty	36
Repair Parts	37-38
Notes	39



www.raynor.com

Raynor Garage Doors
 1101 E. River Rd.
 Dixon, Illinois 61021

Preparation

Safety Symbol and Signal Word Review

This garage door opener has been designed and tested to offer safe service provided it is installed, operated, maintained and tested in strict accordance with the instructions and warnings contained in this manual.

When you see these Safety Symbols and Signal Words on the following pages, they will alert you to the possibility of **serious injury or death** if you do not comply with the warnings that accompany them. The hazard may come from something mechanical or from electric shock. Read the warnings carefully.

WARNING

Mechanical

WARNING

Electrical

When you see this Signal Word on the following pages, it will alert you to the possibility of damage to your garage door and/or the garage door opener if you do not comply with the cautionary statements that accompany it. Read them carefully.

CAUTION

Check the Door

1. Disable locks and remove any ropes connected to the garage door.
2. Lift the door halfway up. Release the door. If balanced, it should stay in place, supported entirely by its springs.
3. Raise and lower the door to check for binding or sticking. If your door binds, sticks, or is out of balance, call a trained door systems technician.
4. Check the seal on the bottom of the door. Any gap between the floor and the bottom of the door must not exceed 1/4 inch (6 mm). Otherwise, the safety reversal system may not work properly.
5. The opener should be installed above the center of the door. If there is a torsion spring or center bearing plate in the way of the header bracket, it may be installed within 4 feet (1.2 m) to the left or right of the door center. See page 7.

Torsion Spring **OR** Extension Spring

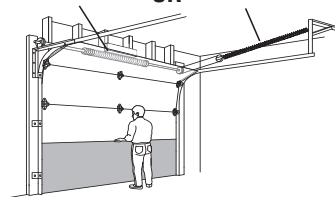

WARNING

To prevent possible **SERIOUS INJURY** or **DEATH**:

- ALWAYS call a trained door systems technician if garage door binds, sticks, or is out of balance. An unbalanced garage door may NOT reverse when required.
- NEVER try to loosen, move or adjust garage door, door springs, cables, pulleys, brackets or their hardware, ALL of which are under **EXTREME** tension.
- Disable ALL locks and remove ALL ropes connected to garage door **BEFORE** installation and operating garage door opener to avoid entanglement.

CAUTION

To prevent damage to garage door and opener:

- ALWAYS disable locks **BEFORE** installing and operating the opener.
- **ONLY** operate garage door opener at 120 V, 60 Hz to avoid malfunction and damage.

Tools Needed

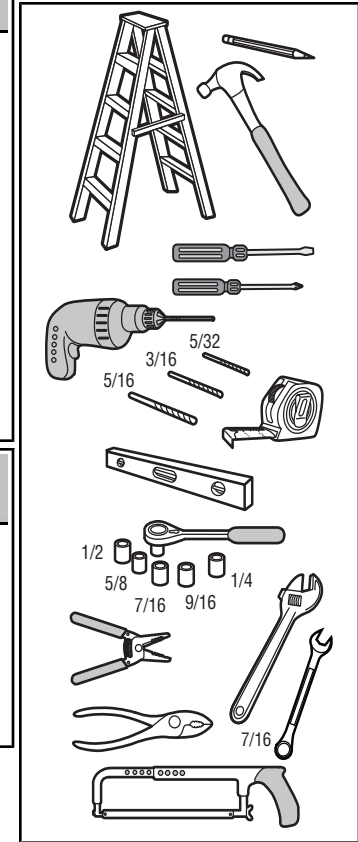

Preparation

Carton Inventory

NOTE: Accessories will vary depending on the garage door opener model purchased. Depending on your specific model, other accessories may be included with your garage door opener. The instructions for these accessories will be attached to the accessory and are not included in this manual. The images throughout this manual are for reference and your product may look different.

- | | | |
|------------------------------|---|--|
| A. Header bracket | F. Trolley | J. Sprocket cover with hex screws |
| B. Pulley and bracket | G. Emergency release rope and handle | K. Belt |
| C. Door bracket | H. Rail | L. Door control |
| D. Curved door arm | I. Garage door opener | M. White and red/white wire |
| E. Straight door arm | | N. The Protector System® |

Safety reversing sensors with white and white/black wire attached: Sending Sensor (1) Receiving Sensor (1) and Safety Sensor Brackets (2)

- | |
|--|
| O. Safety labels and literature |
| P. Rail grease |

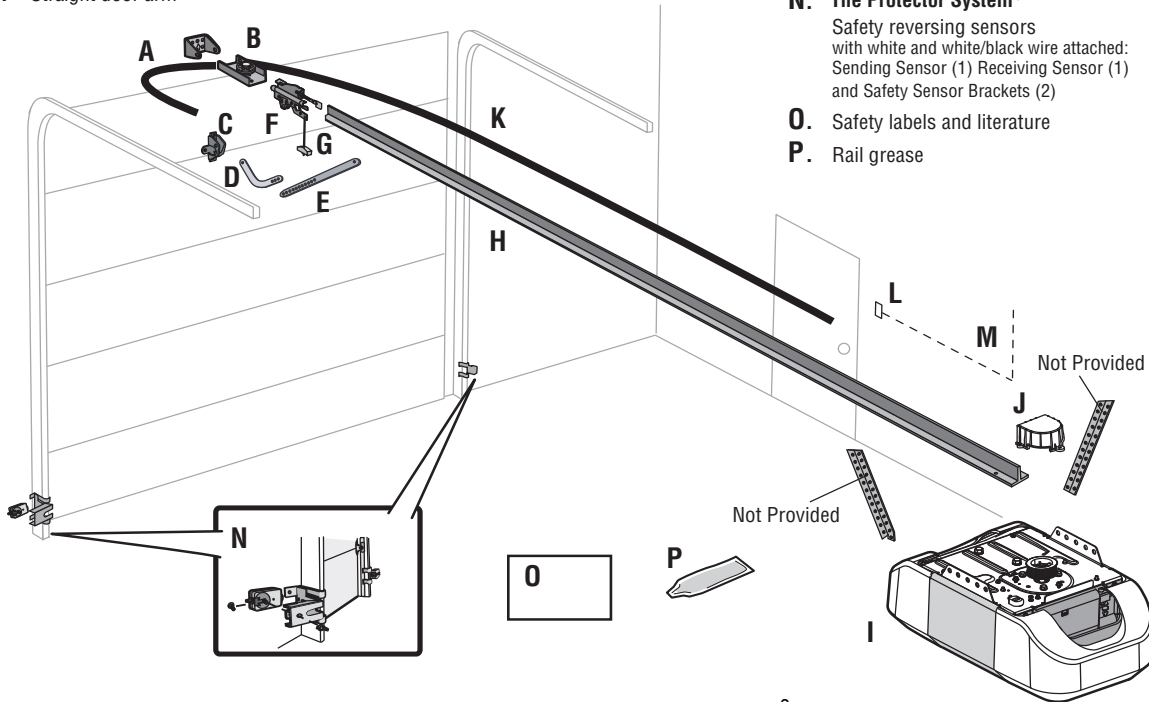

SECURITY+ 2.0™ ACCESSORIES

041A7185-2
Multi-Function
Door Control



893RGX
Remote Control



Hardware

Installation

- Hex Bolt 5/16"-18 x 7/8" (4)
- Lag Screw 5/16"-9 x 1-5/8" (2)
- Clevis Pin 5/16" x 2-3/4" (1)
- Clevis Pin 5/16" x 1-1/4" (1)
- Clevis Pin 5/16" x 1" (1)
- Nut 5/16"-18 (4)
- Lock Washer 5/16" (4)
- Self-Threading Screw 1/4"-14 x 5/8" (2)
- Ring Fastener (3)
- Carriage Bolt 1/4"-20 x 1/2" (8)
- Wing Nut 1/4"-20 (2)

Door Control Hardware

- Screw 6AB x 1" (2)
- Screw 6-32 x 1" (2)
- Drywall Anchors (2)
- Insulated Staples

Assembly

1 Attach the rail to the garage door opener

WARNING

To avoid possible SERIOUS INJURY to finger from moving garage door opener:

- ALWAYS keep hand clear of sprocket while operating opener.
- Securely attach sprocket cover BEFORE operating.

CAUTION

To avoid SERIOUS damage to garage door opener, use ONLY those bolts/fasteners mounted in the top of the opener.

HARDWARE

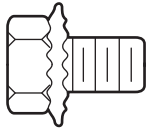

Washed Bolt
5/16"-18x1/2"
(Mounted in the
garage door opener)



Lock Nut
(Mounted in the
garage door opener)



Hex Screw
#8x3/8"
(Packed with the
sprocket cover)

NOTE: ONLY use the bolts removed from the garage door opener. Place the garage door opener on the packing material to prevent scratching.

- 1.1 Remove bolt and lock nut from the top of the garage door opener.
- 1.2 Align the rail and the styrofoam over the sprocket. Cut the tape from the rail, belt, and styrofoam.
- 1.3 Fasten the rail with the previously removed washed bolt and lock nut.
- 1.4 Position the belt around the garage door opener sprocket.
- 1.5 Attach the sprocket cover over the garage door opener sprocket and attach with hex screws.

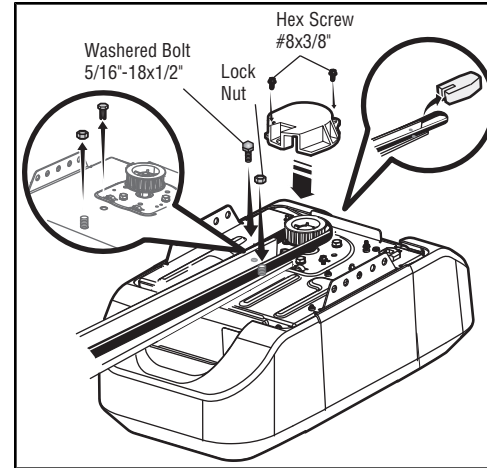

2 Tighten the Belt

- 2.1** By hand, thread the spring trolley nut on the threaded shaft until it is finger tight against the trolley. Do not use any tools.

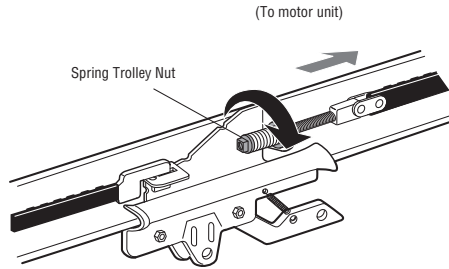

- 2.2** Insert a flathead screwdriver tip into one of the nut ring slots and brace it firmly against the trolley.

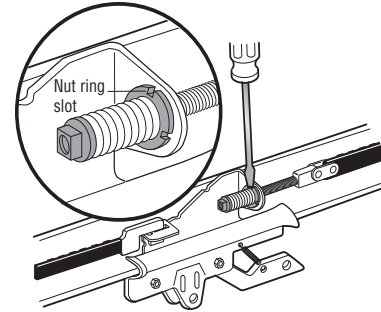

- 2.3** Tighten the spring trolley nut with an adjustable wrench or a 7/16" open end wrench about a quarter turn until the spring releases and snaps the nut ring against the trolley. This sets the spring to optimum belt tension.

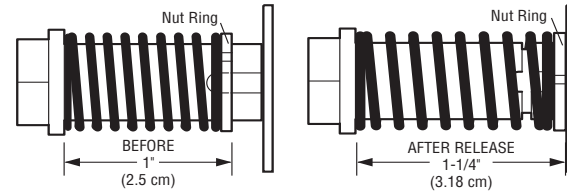
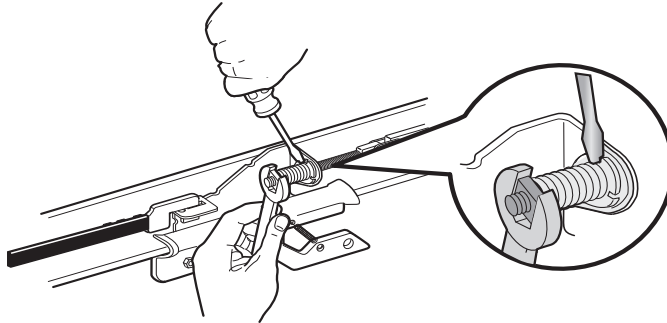

IMPORTANT INSTALLATION INSTRUCTIONS



To reduce the risk of SEVERE INJURY or DEATH:

1. READ AND FOLLOW ALL INSTALLATION WARNINGS AND INSTRUCTIONS.
2. Install garage door opener ONLY on properly balanced and lubricated garage door. An improperly balanced door may NOT reverse when required and could result in SEVERE INJURY or DEATH.
3. ALL repairs to cables, spring assemblies and other hardware MUST be made by a trained door systems technician BEFORE installing opener.
4. Disable ALL locks and remove ALL ropes connected to garage door BEFORE installing opener to avoid entanglement.
5. Install garage door opener 7 feet (2.13 m) or more above floor.
6. Mount the emergency release within reach, but at least 6 feet (1.83 m) above the floor and avoiding contact with vehicles to avoid accidental release.
7. NEVER connect garage door opener to power source until instructed to do so.
8. NEVER wear watches, rings or loose clothing while installing or servicing opener. They could be caught in garage door or opener mechanisms.
9. Install wall-mounted garage door control:
 - within sight of the garage door.
 - out of reach of children at minimum height of 5 feet (1.5 m).
 - away from ALL moving parts of the door.
10. Place entrapment warning label on wall next to garage door control.
11. Place manual release/safety reverse test label in plain view on inside of garage door.
12. Upon completion of installation, test safety reversal system. Door MUST reverse on contact with a 1-1/2" (3.8 cm) high object (or a 2x4 laid flat) on the floor.
13. To avoid SERIOUS PERSONAL INJURY or DEATH from electrocution, disconnect ALL electric and battery power BEFORE performing ANY service or maintenance.
14. DO NOT enable the Timer-to-Close functionality if operating either one-piece or swinging garage doors. To be enabled ONLY when operating a sectional door.

NOTE: If you are installing the garage door opener on a one-piece door, visit www.raynor.com for installation instructions.

1 Determine the header bracket location

WARNING

To prevent possible SERIOUS INJURY or DEATH:

- Header bracket MUST be RIGIDLY fastened to structural support on header wall or ceiling, otherwise garage door might NOT reverse when required. DO NOT install header bracket over drywall.
- Concrete anchors MUST be used if mounting header bracket or 2x4 into masonry.
- NEVER try to loosen, move or adjust garage door, springs, cables, pulleys, brackets, or their hardware, ALL of which are under EXTREME tension.
- ALWAYS call a trained door systems technician if garage door binds, sticks, or is out of balance. An unbalanced garage door might NOT reverse when required.
- DO NOT enable the Timer-to-Close functionality if operating either one-piece or swinging garage doors. To be enabled ONLY when operating a sectional door.

NOTE: If you are installing the garage door opener on a one-piece door, visit www.raynor.com for installation instructions.

- 1.1** Close the door and mark the inside vertical centerline of the garage door.
- 1.2** Extend the line onto the header wall above the door.
You can fasten the header bracket within 4 feet (1.22 m) of the left or right of the door center only if a torsion spring or center bearing plate is in the way; or you can attach it to the ceiling when clearance is minimal. (It may be mounted on the wall upside down if necessary, to gain approximately 1/2" (1 cm).
If you need to install the header bracket on a 2x4 (on wall or ceiling), use lag screws (not provided) to securely fasten the 2x4 to structural supports.
- 1.3** Open your door to the highest point of travel as shown. Draw an intersecting horizontal line on the header wall 2" (5 cm) above the high point. This height will provide travel clearance for the top edge of the door.

NOTE: If the total number of inches exceeds the height available in your garage, use the maximum height possible, or refer to page 8 for ceiling installation.

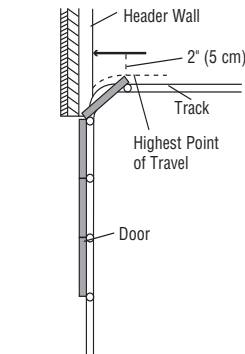
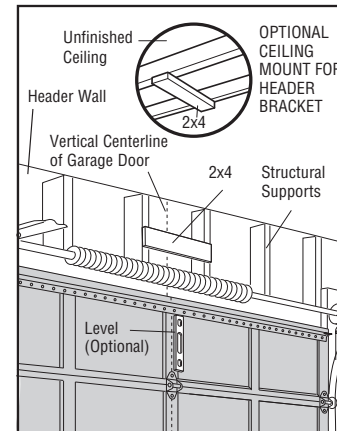

Sectional door with curved track

Installation

2 Install the Header Bracket

You can attach the header bracket either to the wall above the garage door, or to the ceiling. Follow the instructions which will work best for your particular requirements. **Do not install the header bracket over drywall. If installing into masonry, use concrete anchors (not provided).**

HARDWARE

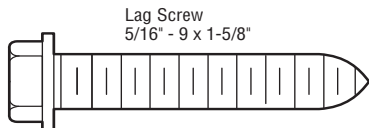

OPTION A WALL INSTALLATION

- 2.1A** Center the bracket on the vertical centerline with the bottom edge of the bracket on the horizontal line as shown (with the arrow pointing toward the ceiling).
- 2.2A** Mark the vertical set of bracket holes (do not use the holes designated for ceiling mount). Drill 3/16" pilot holes and fasten the bracket securely to a structural support with lag screws.

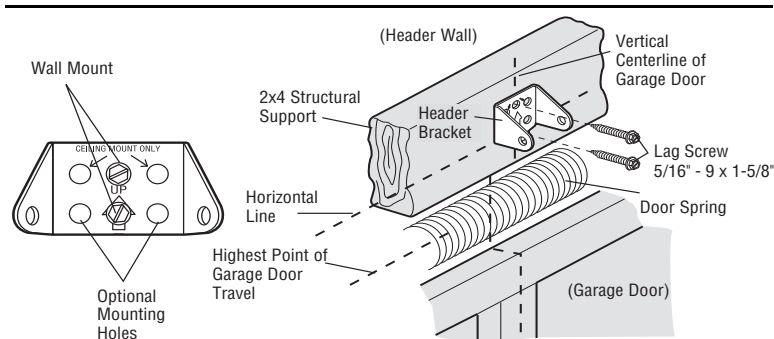

OPTION B CEILING INSTALLATION

- 2.1B** Extend the vertical centerline onto the ceiling as shown.
- 2.2B** Center the bracket on the vertical mark, no more than 6" (15 cm) from the wall. Make sure the arrow is pointing toward the wall. The bracket can be mounted flush against the ceiling when clearance is minimal.
- 2.3B** Mark the side holes. Drill 3/16" pilot holes and fasten bracket securely to a structural support with lag screws.

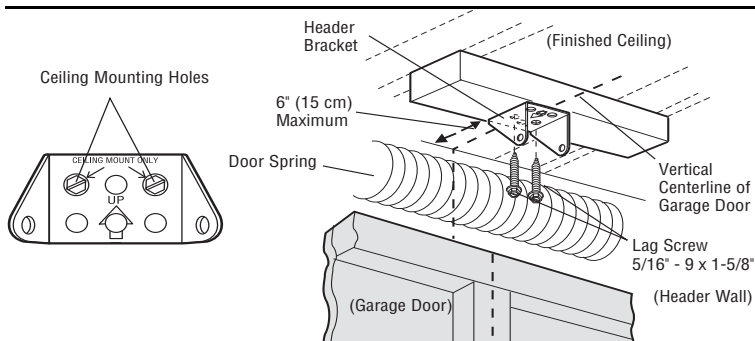

3 Attach the rail to the header bracket

- 3.1** Align the rail with the header bracket. Insert the clevis pin through the holes in the header bracket and rail. Secure with the ring fastener.

NOTE: Use the packing material as a protective base for the garage door opener.

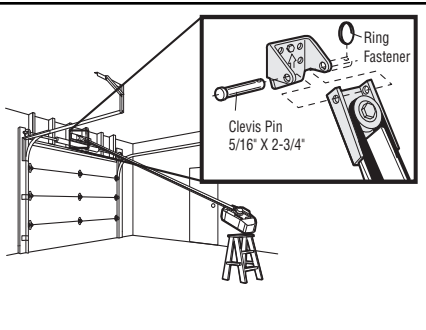

HARDWARE

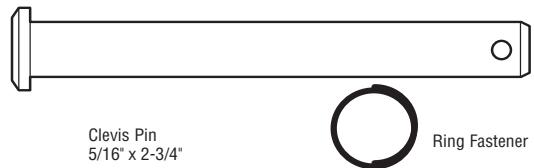

4 Position the garage door opener

CAUTION

To prevent damage to garage door, rest garage door opener rail on 2x4 placed on top section of door.

- 4.1** Remove the packing material and lift the garage door opener onto a ladder.

NOTE: A 2x4 is ideal for setting the distance between the rail and the door. If the ladder is not tall enough you will need help at this point.

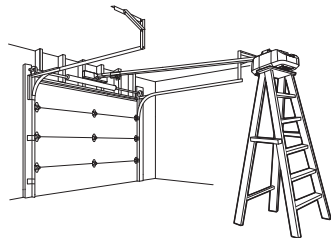

- 4.2** Fully open the door and place a 2x4 (laid flat) under the rail.

NOTE: If the door hits the trolley when it is raised, pull the trolley release arm down to disconnect the inner and outer trolley. Slide the outer trolley toward the garage door opener. The trolley can remain disconnected until instructed.

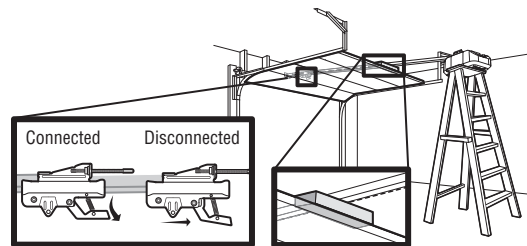

Installation

5 Hang the garage door opener

WARNING

To avoid possible **SERIOUS INJURY** from a falling garage door opener, fasten it **SECURELY** to structural supports of the garage. Concrete anchors **MUST** be used if installing **ANY** brackets into masonry.

HARDWARE

Lock Washer
5/16"



Hex Bolt 5/16" - 18x7/8"

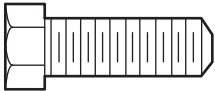

Nut 5/16"-18



Hanging your garage door opener will vary depending on your garage. Two representative installations are shown. Yours may be different. Hanging brackets should be angled (Figure 1) to provide rigid support. On finished ceilings (Figure 2), attach a sturdy metal bracket to structural supports before installing the opener. This bracket and fastening hardware are not provided. Instructions below are for attaching the garage door opener directly to structural supports.

- 5.1** Measure the distance from each side of the motor unit to the structural support.
- 5.2** Cut both pieces of the hanging bracket to required lengths.
- 5.3** Drill 3/16" pilot holes in the structural supports.
- 5.4** Attach one end of each bracket to a support with 5/16"-18x1-7/8" lag screws (not provided).
- 5.5** Fasten the opener to the hanging brackets with 5/16"-18x7/8" hex bolts, lock washers and nuts.
- 5.6** Check to make sure the rail is centered over the door (or in line with the header bracket if the bracket is not centered above the door).
- 5.7** Remove the 2x4. Operate the door manually. If the door hits the rail, raise the header bracket.

NOTE: *DO NOT* connect power to opener at this time.

FIGURE 1

Unfinished Ceiling

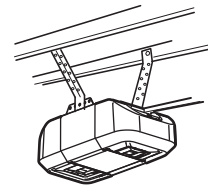

FIGURE 2

Finished Ceiling

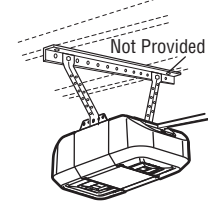
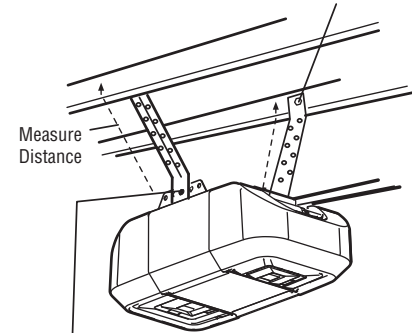

FIGURE 3

(Not Provided)
Lag Screws
5/16" - 18x1-7/8"



Hex Bolt 5/16" - 18x7/8", Lock Washer 5/16", Nut 5/16"-18

6 Install the light bulbs

CAUTION

To prevent possible OVERHEATING of the end panel or light socket:

- Use ONLY A19 incandescent (100W maximum) or compact fluorescent (26W maximum) light bulbs.
- DO NOT use incandescent bulbs larger than 100W.
- DO NOT use compact fluorescent light bulbs larger than 26W (100W equivalent).

To prevent damage to the opener:

- DO NOT use halogen bulbs.
- DO NOT use short neck or specialty light bulbs.

6.1 Pull on the top center of the light lens and rotate the light lens down.

6.2 Insert an A19 incandescent (100W maximum) or compact fluorescent (26W, 100W equivalent) light bulb into the light socket.

NOTE: Do not use halogen, short neck, or specialty light bulbs as these may overheat the end panel or light socket. Do not use LED bulbs as they may reduce the range or performance of your remote control(s).

6.3 Rotate the lens up to close.

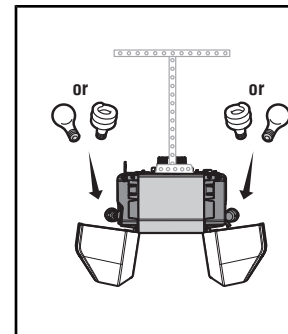

7 Attach the emergency release rope and handle

WARNING

To prevent possible SERIOUS INJURY or DEATH from a falling garage door:

- If possible, use emergency release handle to disengage trolley ONLY when garage door is CLOSED. Weak or broken springs or unbalanced door could result in an open door falling rapidly and/or unexpectedly.
- NEVER use emergency release handle unless garage doorway is clear of persons and obstructions.
- NEVER use handle to pull door open or closed. If rope knot becomes untied, you could fall.

7.1 Insert one end of the emergency release rope through the handle. Make sure that "NOTICE" is right side up. Tie a knot at least 1 inch (2.5 cm) from the end of the emergency release rope.

7.2 Insert the other end of the emergency release rope through the hole in the trolley release arm. Mount the emergency release within reach, but at least 6 feet (1.83 m) above the floor, avoiding contact with vehicles to prevent accidental release and secure with a knot.

NOTE: If it is necessary to cut the emergency release rope, seal the cut end with a match or lighter to prevent unraveling. Ensure the emergency release rope and handle are above the top of all vehicles to avoid entanglement.

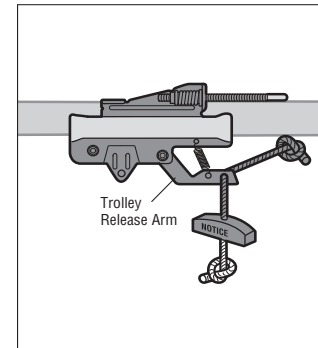

Installation

8 Install the door bracket

CAUTION

Fiberglass, aluminum or lightweight steel garage doors **WILL REQUIRE** reinforcement BEFORE installation of door bracket. Contact your door manufacturer for reinforcement kit.

Figure 1 shows one piece of angle iron as the horizontal brace. For the vertical brace, 2 pieces of angle iron are used to create a U-shaped support. The best solution is to check with your garage door manufacturer for an opener installation door reinforcement kit.

NOTE: Many door reinforcement kits provide for direct attachment of the clevis pin and door arm. In this case you will not need the door bracket; proceed to the next step.

HARDWARE

Self-Threading Screw
1/4"-14x5/8"

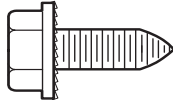

SECTIONAL DOORS

- 8.1** Center the door bracket on the previously marked vertical centerline used for the header bracket installation. Note correct UP placement, as stamped inside the bracket.
- 8.2** Position the top edge of the bracket 2"-4" (5-10 cm) below the top edge of the door, OR directly below any structural support across the top of the door.
- 8.3** Mark, drill holes and install as follows, depending on your door's construction:
 - Metal or light weight doors using a vertical angle iron brace between the door panel support and the door bracket:**
 - Drill 3/16" fastening holes. Secure the door bracket using the two self threading screws. (Figure 2)
 - Alternately, use two 5/16" bolts, lock washers and nuts (not provided). (Figure 3)
 - Metal, insulated or light weight factory reinforced doors:**
 - Drill 3/16" fastening holes. Secure the door bracket using the self-threading screws. (Figure 4)
 - Wood Doors:**
 - Use top and bottom or side to side door bracket holes. Drill 5/16" holes through the door and secure bracket with 5/16"-18x2" carriage bolts, lock washers and nuts (not provided). (Figure 5)

NOTE: The 1/4"-14x5/8" self-threading screws are not intended for use on wood doors.

A horizontal and vertical reinforcement is needed for lightweight garage doors (fiberglass, aluminum, steel, doors with glass panel, etc.) (not provided).

A horizontal reinforcement brace should be long enough to be secured to two or three vertical supports. A vertical reinforcement brace should cover the height of the top panel.

FIGURE 1

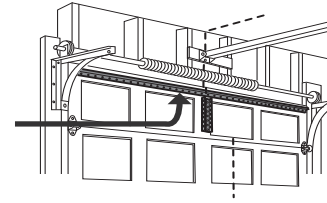

FIGURE 2

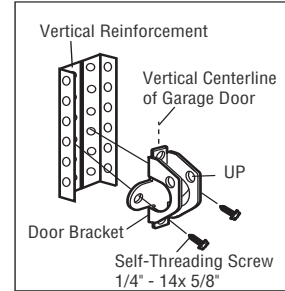

FIGURE 3

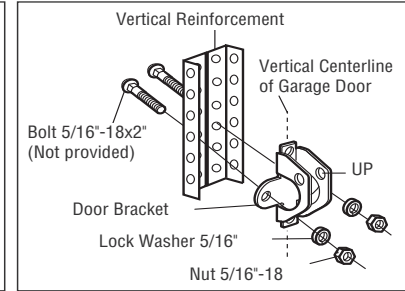

FIGURE 4

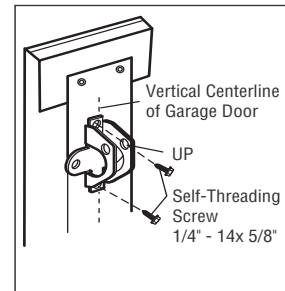
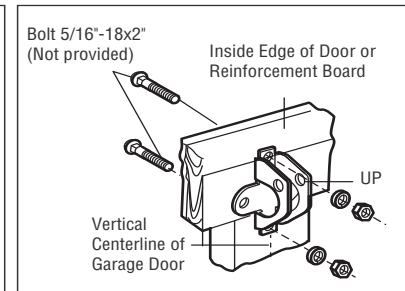
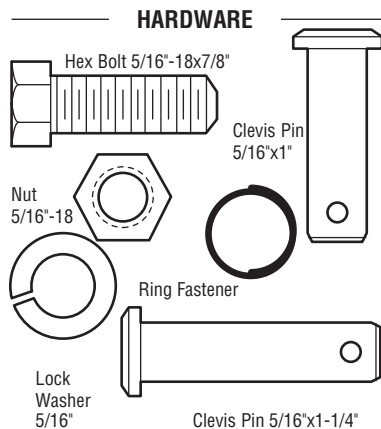
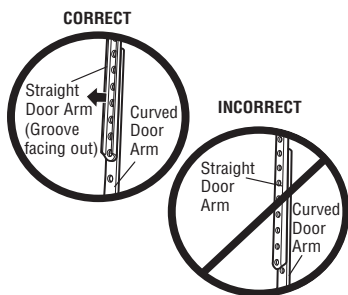

FIGURE 5



9 Connect the door arm to the trolley

IMPORTANT: The groove on the straight door arm **MUST** face away from the curved door arm.



9.1 Close the door. Disconnect the trolley by pulling the emergency release handle. Slide the outer trolley back (away from the door) about 2" (5 cm).

9.2 Attach the straight door arm to the outer trolley using the clevis pin. Attach with the ring fastener.

9.3 Attach the curved door arm to the door bracket using the clevis pin. Attach with the ring fastener.

9.4 Align the straight door arm with the curved door arm. Select two aligned holes (as far apart as possible) and attach using the bolts, nuts and lock washers.

NOTE: If the holes do not line up, reverse the straight door arm. Select two aligned holes (as far apart as possible) and attach using the bolts, nuts and lock washers.

9.5 Pull the emergency release handle toward the garage door opener until the trolley release arm is horizontal. The trolley will re-engage automatically when the garage door opener is activated.

Install the Door Control

1 Install the door control

WARNING

To prevent possible **SERIOUS INJURY** or **DEATH** from electrocution:

- Be sure power is **NOT** connected **BEFORE** installing door control.
- Connect **ONLY** to 12 VOLT low voltage wires.

To prevent possible **SERIOUS INJURY** or **DEATH** from a closing garage door:

- Install door control within sight of garage door, out of reach of children at a minimum height of 5 feet (1.5 m), and away from **ALL** moving parts of door.
- **NEVER** permit children to operate or play with door control push buttons or remote control transmitters.
- Activate door **ONLY** when it can be seen clearly, is properly adjusted, and there are no obstructions to door travel.
- **ALWAYS** keep garage door in sight until completely closed. **NEVER** permit anyone to cross path of closing garage door.

INTRODUCTION

Compatible with MyQ® and Security+ 2.0™ accessories, see page 35. Your garage door opener is compatible with up to 2 Smart Control Panels or 4 of any other Security+ 2.0™ door controls. **NOTE:** Older Raynor door controls and third party products are not compatible.

Install the door control within sight of the door at a minimum height of 5 feet (1.5 m) where small children cannot reach, and away from the moving parts of the door.

NOTE: Your product may look different than moving parts of the door the illustrations.

HARDWARE

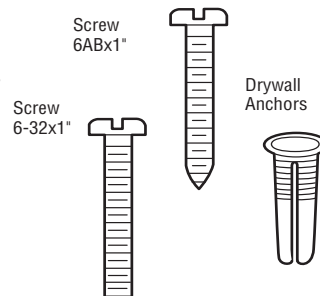

NOTE: For gang box installations it is not necessary to drill holes or install the drywall anchors. Use the existing holes in the gang box.

- 1.1** Strip 7/16 inch (11 mm) of insulation from one end of the wire and separate the wires.

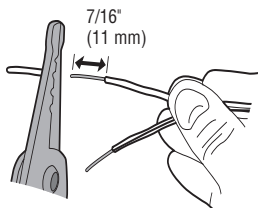

- 1.2** Connect one wire to each of the two screws on the back of the door control. The wires can be connected to either screw.

PRE-WIRED INSTALLATIONS: Choose any two wires to connect, note which wires are used so the correct wires are connected at the garage door opener in a later step.

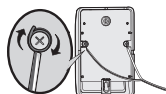

- 1.3** Mark the location of the bottom mounting hole and drill a 5/32 inch (4 mm) hole.

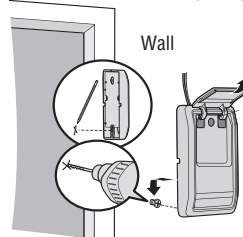

- 1.4** Install the bottom screw, allowing 1/8 inch (3 mm) to protrude from the wall.

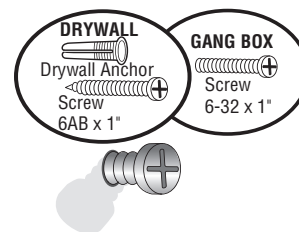

Install the Door Control

1.5 Position the bottom hole of the door control over the screw and slide down into place.

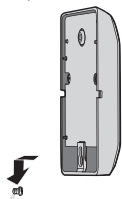

1.6 Lift the push bar up and mark the top hole.

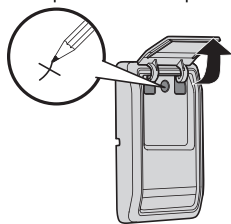

1.7 Remove the door control from the wall and drill a 5/32 inch (4 mm) hole for the top screw.

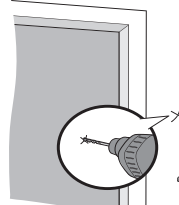

1.8 Position the bottom hole of the door control over the screw and slide down into place. Attach the top screw.

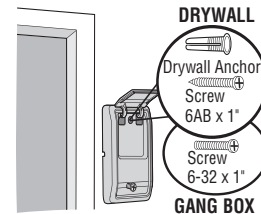

2 Wire the door control to the garage door opener

HARDWARE

Insulated Staple
(Not shown)

PRE-WIRED INSTALLATIONS: When wiring the door control to the garage door opener make sure you use the same wires that are connected to the door control.

2.1 Run the white and red/white wire from the door control to the garage door opener. Attach the wire to the wall and ceiling with the staples (not applicable for gang box or pre-wired installations). Do not pierce the wire with the staple as this may cause a short or an open circuit.

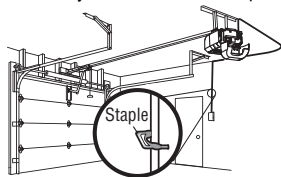

2.2 Strip 7/16 inch (11 mm) of insulation from the end of the wire near the garage door opener.

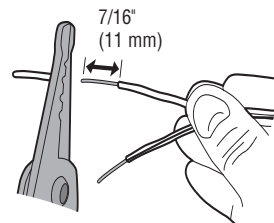

2.3 Connect the wire to the red and white terminals on the garage door opener. To insert or release wires from the terminal, push in the tab with screwdriver tip.

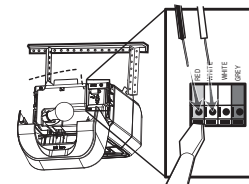

Install the Door Control

3 Attach the warning labels

- 3.1 Attach the entrapment warning label on the wall near the door control with tacks or staples.
- 3.2 Attach the manual release/safety reverse test label in a visible location on the inside of the garage door.

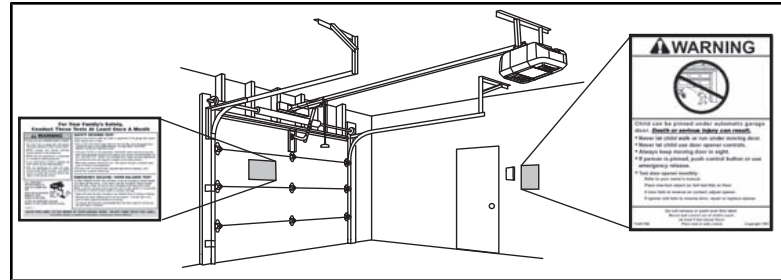

Install the Protector System®

Introduction

WARNING

Be sure power is NOT connected to the garage door opener BEFORE installing the safety reversing sensor.

To prevent SERIOUS INJURY or DEATH from closing garage door:

- Correctly connect and align the safety reversing sensor. This required safety device MUST NOT be disabled.
- Install the safety reversing sensor so beam is NO HIGHER than 6" (15 cm) above garage floor.

IMPORTANT INFORMATION ABOUT THE SAFETY REVERSING SENSORS

The safety reversing sensors must be connected and aligned correctly before the garage door opener will move in the down direction.

The sending sensor (with an amber LED) transmits an invisible light beam to the receiving sensor (with a green LED). If an obstruction breaks the light beam while the door is closing, the door will stop and reverse to the full open position, and the garage door opener lights will flash 10 times.

NOTE: For energy efficiency the garage door opener will enter sleep mode when the door is fully closed. The sleep mode shuts the garage door opener down until activated. The sleep mode is sequenced with the garage door opener light bulb; as the light bulb turns off the sensor LEDs will turn off and whenever the garage door opener lights turn on the sensor LEDs will light. The garage door opener will not go into the sleep mode until the garage door opener has completed 5 cycles upon power up.

When installing the safety reversing sensors check the following:

- Sensors are installed inside the garage, one on either side of the door.
- Sensors are facing each other with the lenses aligned and the receiving sensor lens does not receive direct sunlight.
- Sensors are no more than 6 inches (15 cm) above the floor and the light beam is unobstructed.

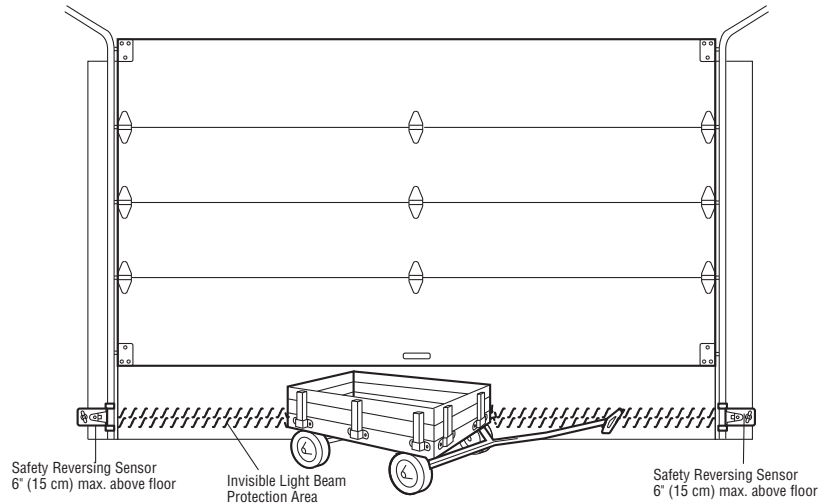

Install the Protector System®

1 Install the Safety Reversing Sensors

The safety reversing sensors can be attached to the door track, the wall, or the floor. If the door track will not support the sensor bracket a wall installation is recommended. Choose one of the following installations.

HARDWARE

Carriage Bolt
1/4"-20x1/2"



Wing Nut
1/4"-20



OPTION A DOOR TRACK INSTALLATION

1.1A Slide the curved arms of the sensor bracket around the edge of the door track. Snap into place so that the sensor bracket is flush against the track.

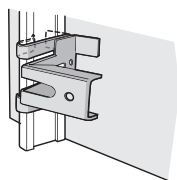

1.2A Slide the carriage bolt into the slot on each sensor.

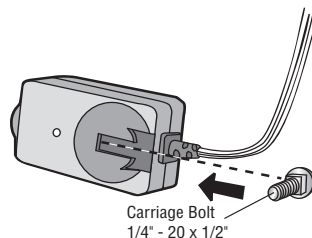

1.3A Insert the bolt through the hole in the sensor bracket and attach with the wing nut. The lenses on both sensors should point toward each other. Make sure the lens is not obstructed by the sensor bracket.

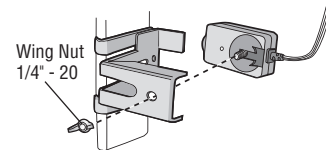

OPTION B WALL INSTALLATION

If additional clearance is needed an extension bracket (not provided) or wood blocks can be used. Make sure each bracket has the same amount of clearance so they will align correctly.

1.1B Position the sensor bracket against the wall with the curved arms facing the door. Make sure there is enough clearance for the beam to be unobstructed. Mark holes.

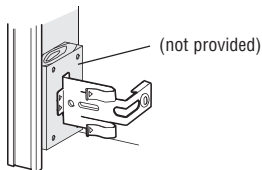

1.2B Drill 3/16 inch pilot holes for each sensor bracket and attach the sensor brackets to the wall using lag screws (not provided).

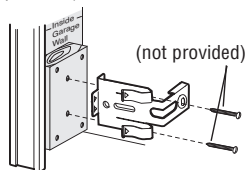

1.3B Slide the carriage bolt into the slot on each sensor.

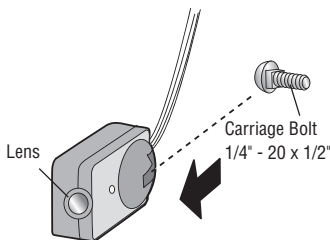

1.4B Insert the bolt through the hole in the sensor bracket and attach with the wing nut. The lenses on both sensors should point toward each other. Make sure the lens is not obstructed by the sensor bracket.

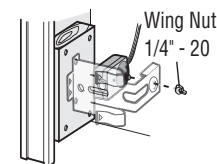

Install the Protector System®

1 Install the Safety Reversing Sensors

OPTION C FLOOR INSTALLATION

Use an extension bracket (not provided) or wood block to raise the sensor bracket if needed.

1.1C Carefully measure the position of both sensor brackets so they will be the same distance from the wall and unobstructed.

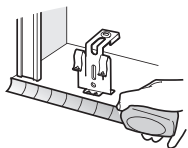

1.2C Attach the sensor brackets to the floor using concrete anchors (not provided).

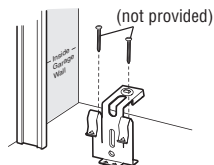

1.3C Slide the carriage bolt into the slot on each sensor.

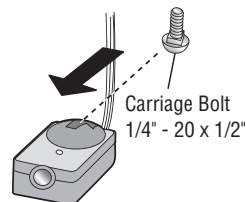

1.4C Insert the bolt through the hole in the sensor bracket and attach with the wing nut. The lens on both sensors should point toward each other. Make sure the lens is not obstructed by the sensor bracket.

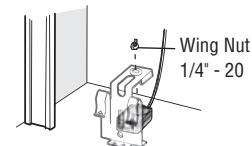

2 Wire the Safety Reversing Sensors

PRE-WIRED INSTALLATIONS: If your garage already has wires installed for the safety reversing sensors, see page 20.

HARDWARE

Insulated Staple
(Not shown)

OPTION A INSTALLATION WITHOUT PRE-WIRING

2.1A Run the wire from both sensors to the garage door opener. Attach the wire to the wall and ceiling with the staples.

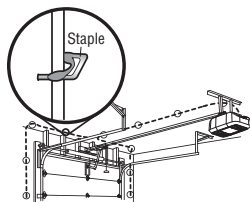

2.2A Strip 7/16 inch (11 mm) of insulation from each set of wires. Separate the wires. Twist the white wires together. Twist the white/black wires together.

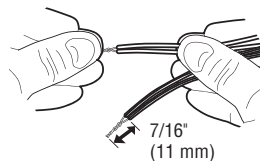

2.3A Insert the white wires into the white terminal on the garage door opener. Insert the white/black wires into the grey terminal on the garage door opener. To insert or remove the wires from the terminal, push in the tab with a screwdriver tip.

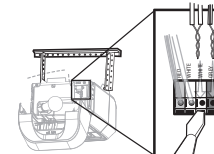

Install the Protector System®

OPTION B PRE-WIRED INSTALLATION

2.1B Cut the end of the safety reversing sensor wire, making sure there is enough wire to reach the pre-installed wires from the wall.

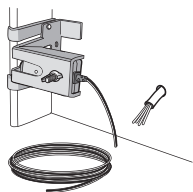

2.2B Separate the safety reversing sensor wires and strip 7/16 inch (11 mm) of insulation from each end. Choose two of the pre-installed wires and strip 7/16 inch (11 mm) of insulation from each end. Make sure that you choose the same color pre-installed wires for each sensor.

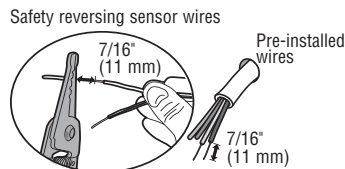

2.3B Connect the pre-installed wires to the sensor wires with wire nuts making sure the colors correspond for each sensor. For example, the white wire would connect to the yellow wire and the white/black wire would connect to the purple wire.

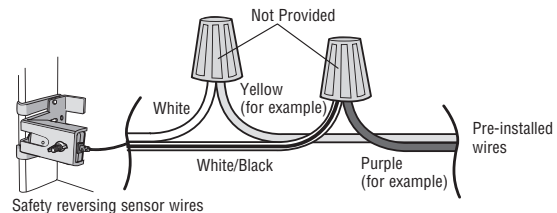

2.4B At the garage door opener, strip 7/16 inch (11 mm) of insulation from each end of the wires previously chosen for the safety reversing sensors. Twist the like-colored wires together.

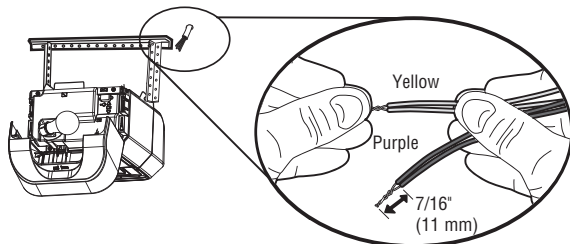

2.5B Insert the wires connected to the white safety sensor wires to the white terminal on the garage door opener. Insert the wires that are connected to the white/black safety sensor wires to the grey terminal on the garage door opener.

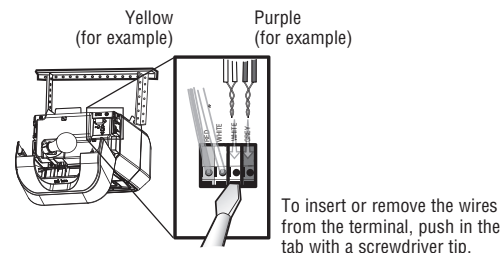

Power

1 Connect Power

WARNING

To prevent possible **SERIOUS INJURY** or **DEATH** from electrocution or fire:

- Be sure power is **NOT** connected to the opener, and disconnect power to circuit **BEFORE** removing cover to establish permanent wiring connection.
- Garage door installation and wiring **MUST** be in compliance with **ALL** local electrical and building codes.
- **NEVER** use an extension cord, 2-wire adapter, or change plug in any way to make it fit outlet. Be sure the opener is grounded.

To avoid installation difficulties, do not activate the garage door opener at this time.

To reduce the risk of electric shock, your garage door opener has a grounding type plug with a third grounding pin. This plug will only fit into a grounding type outlet. If the plug doesn't fit into your outlet, contact a qualified electrician to install the proper outlet.

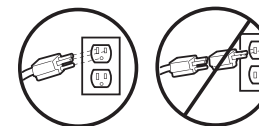

THERE ARE TWO OPTIONS FOR CONNECTING POWER:

OPTION A TYPICAL WIRING

- 1.1A** Plug in the garage door opener into a grounded outlet.
- 1.2A** **DO NOT** run garage door opener at this time.

TYPICAL WIRING

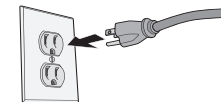

OPTION B PERMANENT WIRING

If permanent wiring is required by your local code, refer to the following procedure.

To make a permanent connection through the 7/8 inch hole in the top of the motor unit (according to local code):

- 1.1B** Remove the motor unit cover screws and set the cover aside.
- 1.2B** Remove the attached 3-prong cord.
- 1.3B** Connect the black (line) wire to the screw on the brass terminal; the white (neutral) wire to the screw on the silver terminal; and the ground wire to the green ground screw. **The opener must be grounded.**
- 1.4B** Reinstall the cover.

PERMANENT WIRING

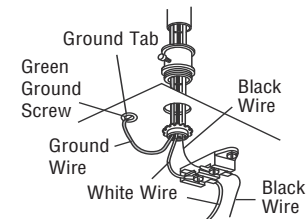

Power

2 Ensure the Safety Reversing Sensors are aligned

The door will not close if the sensors have not been installed and aligned correctly.

- 2.1 Check to make sure the LEDs in both sensors are glowing steadily. The LEDs in both sensors will glow steadily if they are aligned and wired correctly.

When the light beam is obstructed or misaligned while the door is closing, the door will reverse and the garage door opener lights will flash ten times. If the door is already open, it will not close. The sensors can be aligned by loosening the wing nuts, aligning the sensors, and tightening the wing nuts.

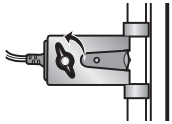
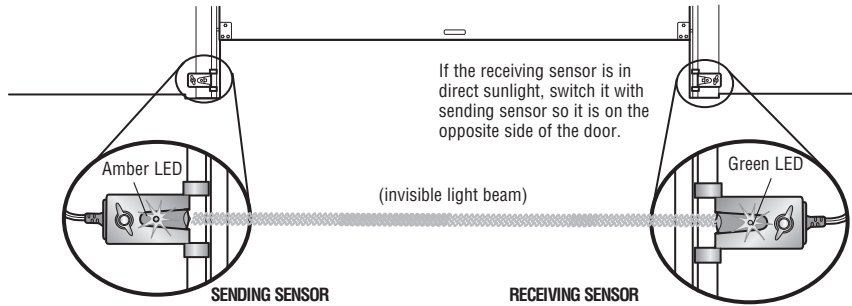

IF THE AMBER LED ON THE SENDING SENSOR IS NOT GLOWING:

Make sure there is power to the garage door opener.

Make sure the sensor wire is not shorted/broken.

Make sure the sensor has been wired correctly: white wires to white terminal and white/black wires to grey terminal.

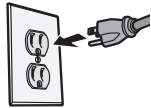

IF THE GREEN LED ON THE RECEIVING SENSOR IS NOT GLOWING:

Make sure the sensor wire is not shorted/broken.

Make sure the sensors are aligned.



3 Ensure the Door Control is wired correctly

If the door control has been installed and wired correctly, the command LED behind the push bar will blink.

Adjustments

WARNING

Without a properly installed safety reversal system, persons (particularly small children) could be SERIOUSLY INJURED or KILLED by a closing garage door.

- Incorrect adjustment of garage door travel limits will interfere with proper operation of safety reversal system.
- After ANY adjustments are made, the safety reversal system MUST be tested. Door MUST reverse on contact with 1-1/2" (3.8 cm) high object (or 2x4 laid flat) on floor.

CAUTION

To prevent damage to vehicles, be sure fully open door provides adequate clearance.

INTRODUCTION

Your garage door opener is designed with electronic controls to make setup and adjustments easy. The adjustments allow you to program where the door will stop in the open (UP) and close (DOWN) position. The electronic controls sense the amount of force required to open and close the door. The force is adjusted automatically when you program the travel.

NOTE: *If anything interferes with the door's upward travel it will stop. If anything interferes with the door's downward travel, it will reverse.*

To watch a short instructional video on programming your new garage door opener use your smartphone to read the QR Code below:



PROGRAMMING BUTTONS

The programming buttons are located on the left side panel of the garage door opener and are used to program the travel.

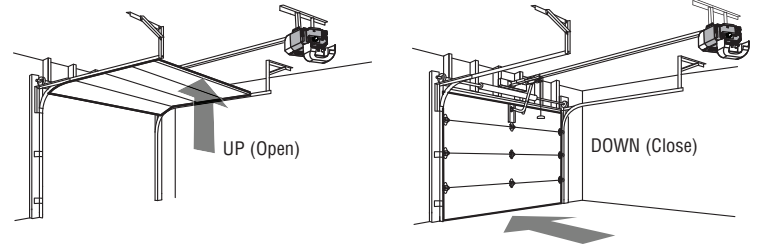

PROGRAMMING BUTTONS

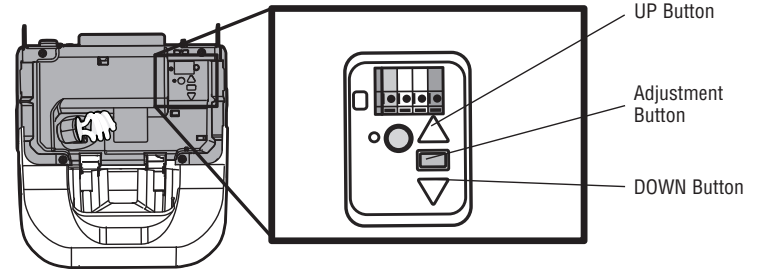

Adjustments

1 Program the Travel

WARNING

Without a properly installed safety reversal system, persons (particularly small children) could be **SERIOUSLY INJURED** or **KILLED** by a closing garage door.

- Incorrect adjustment of garage door travel limits will interfere with proper operation of safety reversal system.
- After **ANY** adjustments are made, the safety reversal system **MUST** be tested. Door **MUST** reverse on contact with 1-1/2" (3.8 cm) high object (or 2x4 laid flat) on floor.

- 1.1** Press and hold the Adjustment Button until the UP Button begins to flash and/or a beep is heard.

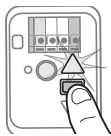

- 1.2** Press and hold the UP Button until the door is in the desired UP position.
NOTE: *The UP and DOWN Buttons can be used to move the door up and down as needed.*



- 1.3** Once the door is in the desired UP position press and release the Adjustment Button. The garage door opener lights will flash twice and the DOWN Button will begin to flash.

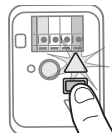

- 1.4** Press and hold the DOWN Button until the door is in the desired DOWN position.
NOTE: *The UP and DOWN Buttons can be used to move the door up and down as needed.*



- 1.5** Once the door is in the desired DOWN position press and release the Adjustment Button. The garage door opener lights will flash twice and the UP Button will begin to flash.

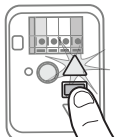

- 1.6** Press and release the UP Button. When the door travels to the programmed UP position, the DOWN Button will begin to flash.



- 1.7** Press and release the DOWN Button. The door will travel to the programmed DOWN position. Programming is complete.



If the garage door opener lights are flashing 5 times during the steps for Program the Travel, the programming has timed out. If the garage door opener lights are flashing 10 times during the steps for Program the Travel, the safety reversing sensors are misaligned or obstructed (refer to page 22). When the sensors are aligned and unobstructed, cycle the door through a complete up and down cycle using the remote control or the UP and DOWN buttons. Programming is complete. If you are unable to operate the door up and down, repeat the steps for Programming the Travel.

Adjustments

2 Test the Safety Reversal System

WARNING

Without a properly installed safety reversal system, persons (particularly small children) could be **SERIOUSLY INJURED** or **KILLED** by a closing garage door.

- Safety reversal system **MUST** be tested every month.
- After **ANY** adjustments are made, the safety reversal system **MUST** be tested. Door **MUST** reverse on contact with 1-1/2" (3.8 cm) high object (or 2x4 laid flat) on the floor.

2.1 With the door fully open, place a 1-1/2 inch (3.8 cm) board (or a 2x4 laid flat) on the floor, centered under the garage door.



2.2 Press the remote control push button to close the door. The door **MUST** reverse when it makes contact with the board.



If the door stops and does not reverse on the obstruction, increase the down travel (refer to Adjustment Step 1).

Repeat the test. When the door reverses upon contact with the 1-1/2 inch board, remove the board and open/close the door 3 or 4 times to test the adjustment.

If the garage door opener continues to fail the safety reversal test, call a trained door systems technician.

3 Test the Protector System®

WARNING

Without a properly installed safety reversing sensor, persons (particularly small children) could be **SERIOUSLY INJURED** or **KILLED** by a closing garage door.

3.1 Open the door. Place the garage door opener carton in the path of the door.



3.2 Press the remote control push button to close the door. The door will not move more than an inch (2.5 cm), and the garage door opener lights will flash 10 times.

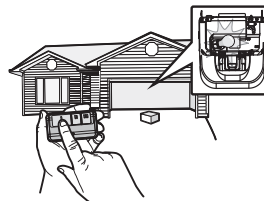

The garage door opener will not close from a remote control if the LED in either safety reversing sensor is off (alerting you to the fact that the sensor is misaligned or obstructed).

If the garage door opener closes the door when the safety reversing sensor is obstructed (and the sensors are no more than 6 inches [15 cm] above the floor), call for a trained door systems technician.

IMPORTANT SAFETY INSTRUCTIONS



To reduce the risk of SEVERE INJURY or DEATH:

1. READ AND FOLLOW ALL WARNINGS AND INSTRUCTIONS.
2. ALWAYS keep remote controls out of reach of children. NEVER permit children to operate or play with garage door control push buttons or remote controls.
3. ONLY activate garage door when it can be seen clearly, it is properly adjusted, and there are no obstructions to door travel.
4. ALWAYS keep garage door in sight and away from people and objects until completely closed. NO ONE SHOULD CROSS THE PATH OF THE MOVING DOOR.
5. NO ONE SHOULD GO UNDER A STOPPED, PARTIALLY OPENED DOOR.
6. If possible, use emergency release handle to disengage trolley ONLY when garage door is CLOSED. Use caution when using this release with the door open. Weak or broken springs or unbalanced door could result in an open door falling rapidly and/or unexpectedly and increasing the risk of SEVERE INJURY or DEATH.
7. NEVER use emergency release handle unless garage doorway is clear of persons and obstructions.
8. NEVER use handle to pull garage door open or closed. If rope knot becomes untied, you could fall.
9. After ANY adjustments are made, the safety reversal system MUST be tested.
10. Safety reversal system MUST be tested every month. Garage door MUST reverse on contact with 1-1/2" (3.8 cm) high object (or a 2x4 laid flat) on the floor. Failure to adjust the garage door opener properly increases the risk of SEVERE INJURY or DEATH.
11. ALWAYS KEEP GARAGE DOOR PROPERLY BALANCED (see page 2). An improperly balanced door may NOT reverse when required and could result in SEVERE INJURY or DEATH.
12. ALL repairs to cables, spring assemblies and other hardware, ALL of which are under EXTREME tension, MUST be made by a trained door systems technician.
13. To avoid SERIOUS PERSONAL INJURY or DEATH from electrocution, disconnect ALL electric and battery power BEFORE performing ANY service or maintenance.
14. This operator system is equipped with an unattended operation feature. The door could move unexpectedly. NO ONE SHOULD CROSS THE PATH OF THE MOVING DOOR.
15. DO NOT enable the Timer-to-Close functionality if operating either one-piece or swinging garage doors. To be enabled ONLY when operating a sectional door.

16. SAVE THESE INSTRUCTIONS.

Features

Your garage door opener is equipped with features to provide you with greater control over your garage door operation.

Alert2Close

The Alert2Close feature provides a visual and an audible alert that an unattended door is closing.

Timer-to-Close (TTC)

The TTC feature automatically closes the door after a specified time period that can be adjusted using a TTC enabled door control. Prior to and during the door closing the garage door opener lights will flash and the garage door opener will beep.

MyQ®

MyQ® technology uses a 900MHz signal to provide two-way communication between the garage door opener and MyQ® enabled accessories. Your garage door opener is compatible with up to 16 MyQ® accessories.

SECURITY+ 2.0™ REMOTE CONTROLS AND DOOR CONTROLS

Your garage door opener has already been programmed at the factory to operate with your remote control, which changes with each use, randomly accessing over 100 billion new codes. Compatible with MyQ® and Security+ 2.0™ accessories, see page 35.

NOTE: Older Raynor remote controls, door controls, and third party products are not compatible.

SECURITY+ 2.0™ Accessories	MEMORY CAPACITY
Remote Controls	Up to 12
Door Controls	Up to 2 Smart Control Panels or 4 of any other Security+ 2.0™ door controls
Keyless Entries	Up to 1

THE PROTECTOR SYSTEM® (SAFETY REVERSING SENSORS)

When properly connected and aligned, the safety reversing sensors will detect an obstruction in the path of the infrared beam. If an obstruction breaks the infrared beam while the door is closing, the door will stop and reverse to full open position, and the opener lights will flash 10 times. If the door is fully open, and the safety reversing sensors are not installed, or are misaligned, the door will not close from a remote control. However, you can close the door if you hold the button on the door control or keyless entry until the door is fully closed. The safety reversing sensors do not affect the opening cycle.

ENERGY CONSERVATION

For energy efficiency the garage door opener will enter sleep mode when the door is fully closed. The sleep mode shuts the garage door opener down until activated. The sleep mode is sequenced with the garage door opener light bulb; as the light bulb turns off the sensor LEDs will turn off and whenever the garage door opener lights turn on the sensor LEDs will light. The garage door opener will not go into the sleep mode until the garage door opener has completed 5 cycles upon power up.

LIGHTS

The garage door opener light bulbs will turn on when the opener is initially plugged in; power is restored after interruption, or when the garage door opener is activated. The lights will turn off automatically after 4-1/2 minutes. An incandescent A19 light bulb (100 watt maximum) or for maximum energy efficiency a 26W (100W equivalent) compact fluorescent light (CFL) bulb may be used.

Light Feature

The garage door opener is equipped with an added feature; the lights will turn on when someone enters through the open garage door and the safety reversing sensor infrared beam is broken. For added control over the light bulbs on your garage door opener, see page 29.

USING YOUR GARAGE DOOR OPENER

The garage door opener can be activated through a wall-mounted door control, remote control, wireless keyless entry or MyQ® accessory. When the door is closed and the garage door opener is activated the door will open. If the door senses an obstruction or is interrupted while opening the door will stop. When the door is in any position other than closed and the garage door opener is activated the door will close. If the garage door opener senses an obstruction while closing, the door will reverse. If the obstruction interrupts the sensor beam the garage door opener lights will blink 10 times. However, you can close the door if you hold the button on the door control or keyless entry until the door is fully closed. The safety reversing sensors do not affect the opening cycle. The safety reversing sensor must be connected and aligned correctly before the garage door opener will move in the down direction.

Door Control

USING THE DOOR CONTROL

SYNCHRONIZE THE DOOR CONTROL

To synchronize the door control to the garage door opener, press the push bar until the garage door opener activates (it may take up to 3 presses). Test the door control by pressing the push bar, each press of the push bar will activate the garage door opener.

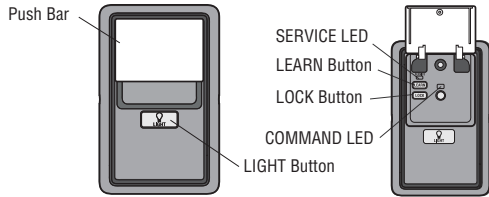

PUSH BAR

Press the push bar to open or close the door.

LIGHT BUTTON

Press the LIGHT button to turn the garage door opener lights on or off. When the lights are turned on they will stay on until the LIGHT button is pressed again, or until the garage door opener is activated. Once the garage door opener is activated the lights will turn off after the specified period of time (the factory setting is 4-1/2 minutes). The LIGHT button will not control the lights when the door is in motion.

The following features are accessible by lifting up the push bar:

LEARN A DEVICE

Any compatible remote controls, wireless keyless entry, or MyQ® accessories can be programmed to the garage door opener by pressing the LEARN button the door control, see page 30.

LOCK

The LOCK feature is designed to prevent activation of the garage door opener from remote controls while still allowing activation from the door control and keyless entry. This feature is useful for added peace of mind when the home is empty (i.e. vacation).

AUTOMATIC LIGHT

Light Feature

The lights will turn on when someone enters through the open garage door and the safety reversing sensor infrared beam is broken.

MAINTENANCE ALERT (MAS)

This feature assists the homeowner in ensuring the garage door opener system stays in good working condition. When the garage door opener needs to be serviced (approximately 4500 garage door opener cycles) the command (yellow) and service (red) LEDs will begin to alternately flash back and forth. The factory setting for the MAS feature is off and can be activated at time of installation. Contact your installing dealer for service.

Door Control

Control Panel Setup

LOCK

NOTE: Your remote controls will NOT work when LOCK mode is active however your keyless entry will still allow access to your garage.

Activate: Press and hold the LOCK button for 2 seconds. The command LED will flash as long as the lock feature is activated and your handheld remote control will not operate your door at this time.

Deactivate: Press and hold the LOCK button again for 2 seconds. The command LED will stop flashing and normal operation will resume.

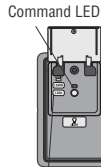

LOCK Button

LIGHT

To change the amount of time the garage door opener lights will stay on:

Press and hold the LOCK button until the garage door opener lights flash.* The time interval is indicated by the number of flashes.

Number of times garage door opener lights flash	Time the garage door opener light stays on
1	1 1/2 Minutes
2	2 1/2 Minutes
3	3 1/2 Minutes
4	4 1/2 Minutes

To cycle through the time intervals repeat the step above.

LIGHT FEATURE (Default is Active)

Deactivate:

Press and hold the LIGHT button until the garage door opener lights turn on, then off again.*

Activate:

Start with the garage door opener lights on. Press and hold the LIGHT button until the garage door opener lights turn off, then on again.*

NOTE: If the command LED is continuously blinking, the LOCK feature needs to be deactivated.

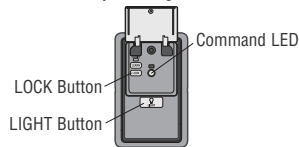

* Approximately 10 seconds

MAINTENANCE ALERT SYSTEM (MAS):

Activate/Deactivate

Press and hold the LEARN button. Then press the LIGHT button. The service LED will flash the status; Active is 2 flashes and deactivated is 3 flashes.

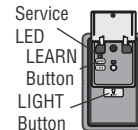



Remote Control

Your remote control has been programmed at the factory to operate with your garage door opener.

Older Raynor remote controls are NOT compatible, see page 35 for compatible accessories. Programming can be done through the door control or the learn button the garage door opener. To program additional accessories refer to the instructions provided with the accessory or visit www.raynor.com. If your vehicle is equipped with a Homelink®, you may require an external adapter depending on the make, model, and year of your vehicle. Visit www.homelink.com for additional information.

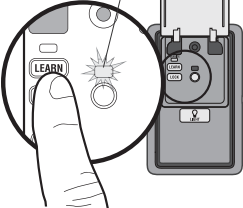
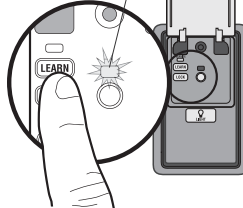
TO ADD, REPROGRAM, OR CHANGE A REMOTE CONTROL/KEYLESS ENTRY PIN USING THE DOOR CONTROL

<p>1 Press the LEARN button on the door control to enter Programming Mode. The command LED will flash once.</p> 	<p>2 Press the LEARN button again, the LED will flash once. The command LED will flash once again.</p> 	<p>3 Remote Control: Press the button on the remote control that you wish to operate your garage door.</p> <p>Keyless Entry: Enter a 4-digit personal identification number (PIN) of your choice on the keyless entry keypad. Then press the ENTER button.</p> <p>The garage door opener lights will flash (or two clicks will be heard) when the code has been programmed. Repeat the steps above for programming additional remote controls or keyless entry devices. If programming is unsuccessful, program the remote using the learn button.</p> 
--	---	--

PROGRAM USING THE GARAGE DOOR OPENER

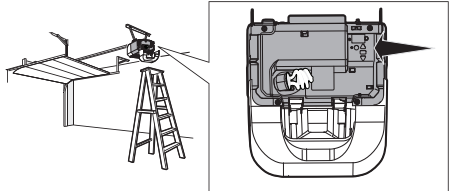
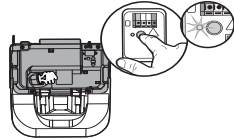
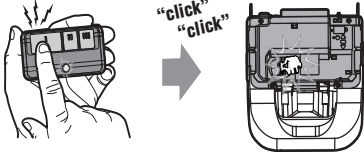
<p>1 Locate the Learn Button.</p> 	<p>2 Press and immediately release the Learn button. The Learn LED will glow steady for 30 seconds. Within 30 seconds...</p> 	<p>3 Press and hold the button the remote control that you wish to use. Release the button when the garage door opener lights blink or two clicks are heard. If programming to other products, press the button a second time to activate products.</p> 
--	---	---

Remote Control

To Erase the Memory

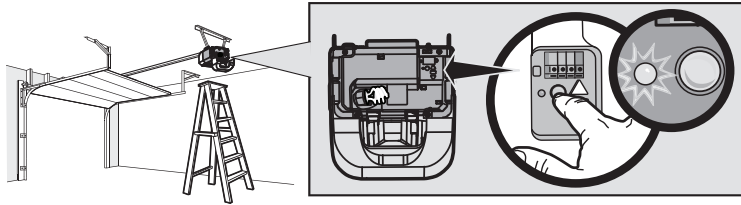

ERASE ALL REMOTE CONTROLS AND KEYLESS ENTRIES

- 1 Press and hold the learn button on garage door opener until the learn LED goes out (approximately 6 seconds). All remote control and keyless entry codes are now erased. Reprogram any accessory you wish to use.

ERASE ALL DEVICES (Including MyQ® enabled accessories)

- 1 Press and hold the learn button on garage door opener until the learn LED goes out (approximately 6 seconds).
- 2 Immediately press and hold the learn button again until the learn LED goes out. All codes are now erased. Reprogram any accessory you wish to use.

To Open the Door Manually

WARNING

To prevent possible **SERIOUS INJURY** or **DEATH** from a falling garage door:

- If possible, use emergency release handle to disengage trolley **ONLY** when garage door is **CLOSED**. Weak or broken springs or unbalanced door could result in an open door falling rapidly and/or unexpectedly.
- **NEVER** use emergency release handle unless garage doorway is clear of persons and obstructions.
- **NEVER** use handle to pull door open or closed. If rope knot becomes untied, you could fall.

Maintenance

EVERY MONTH

- Manually operate door. If it is unbalanced or binding, call a trained door systems technician.
- Check to be sure door opens and closes fully. Adjust if necessary, see page 24.
- Test the safety reversal system. Adjust if necessary, see page 25.

EVERY YEAR

- Oil door rollers, bearings and hinges. The garage door opener does not require additional lubrication. Do not grease the door tracks.

EVERY TWO TO THREE YEARS

- Use a rag to wipe away the existing grease from the garage door opener rail. Reapply a small layer of white lithium grease to the top and underside of the rail surface where the trolley slides.

NOTICE: To comply with FCC and/or Industry Canada (IC) rules, adjustment or modifications of this receiver are prohibited. **THERE ARE NO USER SERVICEABLE PARTS.** Any changes or modifications not expressly approved by the party responsible for compliance could void the user's authority to operate the equipment.

This device complies with Part 15 of the FCC rules and IC RSS-210. Operation is subject to the following two conditions: (1) this device may not cause harmful interference, and (2) this device must accept any interference received, including interference that may cause undesired operation.

This Class B digital apparatus complies with Canadian ICES-003.

AVIS: Les règles de la FCC et/ou d'Industrie Canada (IC) interdisent tout ajustement ou toute modification de ce récepteur. **IL N'EXISTE AUCUNE PIÈCE SUSCEPTIBLE D'ÊTRE ENTRETIENUE PAR L'UTILISATEUR.** Tout changement ou toute modification non expressément approuvé par la partie responsable de la conformité peut avoir pour résultat d'annuler l'autorité de l'utilisateur de faire fonctionner l'équipement.

Cet appareil est conforme aux dispositions de la partie 15 du règlement de la FCC et de l' norme IC RSS-210. Son utilisation est assujettie aux deux conditions suivantes: (1) ce dispositif ne peut causer des interférences nuisibles, et (2) ce dispositif doit accepter toute interférence reçue, y compris une interférence pouvant causer un fonctionnement non souhaité.

Cet appareil numérique de la classe B est conforme à la norme NMB-003 du Canada.

DISCONNECT THE TROLLEY

- 1 The door should be fully closed if possible.
- 2 Pull down on the emergency release handle.

RECONNECT THE TROLLEY

The lockout feature prevents the trolley from reconnecting automatically.

- 1 Pull the emergency release handle down and back (toward the opener). The door can then be raised and lowered manually as often as necessary.
- 2 To disengage the lockout feature, pull the handle straight down. The trolley will reconnect on the next UP or DOWN operation, either manually or by using the door control or remote control.

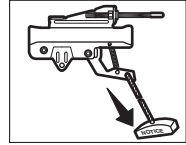
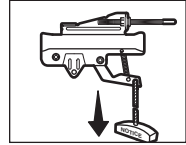

THE REMOTE CONTROL BATTERY

WARNING

To prevent possible **SERIOUS INJURY** or **DEATH**:

- **NEVER** allow small children near batteries.
- If battery is swallowed, immediately notify doctor.
- To reduce risk of fire, explosion or chemical burn:
 - Replace **ONLY** with 3V2032 coin batteries.
 - **DO NOT** recharge, disassemble, heat above 212°F (100°C) or incinerate.

To replace the battery, pry open the case in the middle, then at each side with the visor clip. Insert replacement battery positive side up (+).

Replace the batteries with only 3V2032 coin cell batteries. Dispose of old batteries properly.

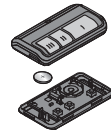

Troubleshooting

Diagnostic Chart

Your garage door opener is programmed with self-diagnostic capabilities. The UP and DOWN arrows on the garage door opener flash the diagnostic codes.

DIAGNOSTIC CODE		SYMPTOM	SOLUTION
Up Arrow Flash(es)	Down Arrow Flash(es)		
1	1	The garage door opener will not close and the light bulbs flash.	Safety sensors are not installed, connected or wires may be cut. Inspect sensor wires for a disconnected or cut wire.
1	2	The garage door opener will not close and the light bulbs flash.	There is a short or reversed wire for the safety sensors. Inspect safety sensor wire at all staple points and connection points and replace wire or correct as needed.
1	3	The door control will not function.	The wires for the door control are shorted or the door control is faulty. Inspect safety sensor wire at all staple points and connection points and replace wire or correct as needed.
1	4	The garage door opener will not close and the light bulbs flash.	Safety sensors are misaligned or were momentarily obstructed. Realign both sensors to ensure both LEDs are steady and not flickering. Make sure nothing is hanging or mounted on the door that would interrupt the sensors path while closing.
1	5	Door moves 6-8" stops or reverses.	Manually open and close the door. Check for binding or obstructions, such as a broken spring or door lock, correct as needed. Check wiring connections at travel module and at the logic board. Replace travel module if necessary.
		No movement, only a single click.	Manually open and close the door. Check for binding or obstructions, such as a broken spring or door lock, correct as needed. Replace logic board if necessary.
		Opener hums for 1-2 seconds no movement.	Manually open and close the door. Check for binding or obstructions, such as a broken spring or door lock, correct as needed. Replace motor if necessary.
1	6	Door coast after it has come to a complete stop.	Program travel to coasting position or have door balanced by a trained technician.
2	1-5	No movement or sound.	Replace logic board.
3	2	Unable to set the travel or retain position.	Check travel module for proper assembly, replace if necessary.

Troubleshooting

DIAGNOSTIC CODE		SYMPTOM	SOLUTION
Up Arrow Flash(es)	Down Arrow Flash(es)		
4	1-4	Door is moving stops and or reverses.	Manually open and close the door. Check for binding or obstructions, such as a broken spring or door lock, correct as needed. If the door is binding or sticking contact a trained door systems technician. If door is not binding or sticking attempt to reprogram travel (refer to page 24).
4	5	Opener runs approximately 6-8", stops and reverses.	Communication error to travel module. Check travel module connections, replace module if necessary.
4	6	The garage door opener will not close and the light bulbs flash.	Safety sensors are misaligned or were momentarily obstructed. Realign both sensors to ensure both LEDs are steady and not flickering. Make sure nothing is hanging or mounted on the door that would interrupt the sensor's path while closing.

The garage door opener can beep for several reasons:

- Garage door opener has been activated through a device or feature such as Timer-to-Close, garage door monitor or LiftMaster Internet Gateway, see page 27.

My remote control will not activate the garage door:

- Verify the lock feature is not activated on the door control.
- Reprogram the remote control.
- If the remote control will still not activate the door check the diagnostic codes to ensure the garage door opener is working properly.

My door will not close and the light bulbs blink on my motor unit:

The safety reversing sensor must be connected and aligned correctly before the garage door opener will move in the down direction.

- Verify the safety sensors are properly installed, aligned and free of any obstructions.

My garage door opener light(s) will not turn off when the door is open:

The garage door opener is equipped with a feature that turns the light on when the safety reversing sensors have been obstructed or when the motion sensor on the door control detects movement in the garage. These features can be disabled using the door control, see page 31 .

My neighbor's remote control opens my garage door:

Erase the memory from your garage door opener and reprogram the remote control(s).

The LEDs on the door control blink:

If you have a Smart Control Panel installed and the TTC is set to a custom time, press the ON button on the Premium Motion-Detecting Control Panel to set the time properly.

My vehicle's Homelink® is not programming to my garage door opener:

Depending on the make, model, and year of your vehicle an external adapter may be required. Visit www.homelink.com for additional information.

Accessories

MAX ACCESSORIES

Compatible with Raynor® garage door openers manufactured since 1993.

877MGX

MAX Wireless Keyless Entry:

For use outside of the home to enable access to the garage using a 4-digit PIN.



895RGX

3-Button Remote Control:

Includes visor clip.



893RGX

3-Button MAX Remote Control:

Includes visor clip.



MyQ® ACCESSORIES

828LG

MyQ® Internet Gateway:

Internet enabled accessory which connects to the computer and allows you to monitor and control garage door openers and lighting accessories enabled by MyQ® technology.



823LM

Remote Light Switch:

Automatically control your lights using your garage door opener, a SECURITY+ 2.0™ remote control or a MyQ® Internet Gateway. Simply replaces your current wired wall switch.



825LM

Remote Light Control:

Automatically control your lights using your garage door opener, a SECURITY+ 2.0™ remote control or a MyQ® Internet Gateway. Plugs into any interior outlet.



829LM

Garage and Gate Monitor:

Monitor open/closed status for up to 4 MyQ® compatible garage door openers or gate operators and close them from anywhere in the home.



STANDARD ACCESSORIES

41A5281-1

Extension Brackets:

(Optional) For safety reversing sensor installation onto the wall or floor.



41A7773-1

Security+ 2.0™ Wireless Door Control:

Push bar, light feature and auxiliary button. Includes battery. SECURITY+ 2.0™ compatible.



990LM

Surge Protector:

The Garage Door Opener Surge Protector is designed to protect Raynor® garage door openers against damage from lightning and power surges. Easy to install.



Warranty

RAYNOR® ONE YEAR LIMITED WARRANTY LIFETIME MOTOR AND BELT LIMITED WARRANTY

RAYNOR® (“Seller”) warrants to the first retail purchaser of this product, for the residence in which this product is originally installed, that it is free from defects in materials and/or workmanship for a period of one year from the date of purchase, except that the motor and belt are warranted to be free from defects in materials and/or workmanship for the lifetime of the product while you own your residence. The proper operation of this product is dependent on your compliance with the instructions regarding installation, operation, and maintenance and testing. Failure to comply strictly with those instructions will void this limited warranty in its entirety.

If, during the limited warranty period, this product appears to contain a defect covered by this limited warranty, call 1-800-528-9131, toll free, before dismantling this product. You will be advised of disassembly and shipping instructions when you call. Then send the product or component, pre-paid and insured, as directed to our service center for warranty repair. Please include a brief description of the problem and a dated proof-of-purchase receipt with any product returned for warranty repair. Products returned to Seller for warranty repair, which upon receipt by Seller are confirmed to be defective and covered by this limited warranty, will be repaired or replaced (at Seller’s sole option) at no cost to you and returned pre-paid. Defective parts will be repaired or replaced with new or factory-rebuilt parts at Seller’s sole option. [You are responsible for any costs incurred in removing and/or reinstalling the product or any component .]

ALL IMPLIED WARRANTIES FOR THE PRODUCT, INCLUDING BUT NOT LIMITED TO ANY IMPLIED WARRANTIES OF MERCHANTABILITY AND FITNESS FOR A PARTICULAR PURPOSE, ARE LIMITED IN DURATION TO THE APPLICABLE LIMITED WARRANTY PERIOD SET FORTH ABOVE FOR THE RELATED COMPONENT(S), AND NO IMPLIED WARRANTIES WILL EXIST OR APPLY AFTER SUCH PERIOD. Some States do not allow limitations on how long an implied warranty lasts, so the above limitation may not apply to you. THIS LIMITED WARRANTY DOES NOT COVER NON-DEFECT DAMAGE, DAMAGE CAUSED BY IMPROPER INSTALLATION, OPERATION OR CARE (INCLUDING, BUT NOT LIMITED TO ABUSE, MISUSE, FAILURE TO PROVIDE REASONABLE AND NECESSARY MAINTENANCE, UNAUTHORIZED REPAIRS OR ANY ALTERATIONS TO THIS PRODUCT), LABOR CHARGES FOR REINSTALLING A REPAIRED OR REPLACED UNIT, REPLACEMENT OF CONSUMABLE ITEMS (E.G., BATTERIES IN REMOTE CONTROL TRANSMITTERS AND LIGHT BULBS), OR UNITS INSTALLED FOR NON-RESIDENTIAL USE. THIS LIMITED WARRANTY DOES NOT COVER ANY PROBLEMS WITH, OR RELATING TO, THE GARAGE DOOR OR GARAGE DOOR HARDWARE, INCLUDING BUT NOT LIMITED TO THE DOOR SPRINGS, DOOR ROLLERS, DOOR ALIGNMENT OR HINGES. THIS LIMITED WARRANTY ALSO DOES NOT COVER ANY PROBLEMS CAUSED BY INTERFERENCE. UNDER NO CIRCUMSTANCES SHALL SELLER BE LIABLE FOR CONSEQUENTIAL, INCIDENTAL OR SPECIAL DAMAGES ARISING IN CONNECTION WITH USE, OR INABILITY TO USE, THIS PRODUCT. IN NO EVENT SHALL SELLER’S LIABILITY FOR BREACH OF WARRANTY, BREACH OF CONTRACT, NEGLIGENCE OR STRICT LIABILITY EXCEED THE COST OF THE PRODUCT COVERED HEREBY. NO PERSON IS AUTHORIZED TO ASSUME FOR US ANY OTHER LIABILITY IN CONNECTION WITH THE SALE OF THIS PRODUCT.

Some states do not allow the exclusion or limitation of consequential, incidental or special damages, so the above limitation or exclusion may not apply to you. This limited warranty gives you specific legal rights, and you may also have other rights, which vary from state to state.

Repair Parts

Rail Assembly Parts

Description	Part Number
1 Belt - for 7 foot door	41A5434-11
Belt - for 8 foot door	41A5434-13
Belt - for 10 foot door	41A5434-14
2 Belt Pulley Bracket	41B5424
3 Master Link	4A1008
4 One-Piece Rail 7 feet (2.1 m)	2777BD
One-Piece Rail 8 feet (2.4 m)	2778BD
One-Piece Rail 10 feet (3 m)	2770BD
5 Trolley Assembly	41B3869-3A
6 Tensioner Assembly	41B4103
7 Trolley Threaded Shaft	109B48
Not Shown	
Owner's Manual	114A4620

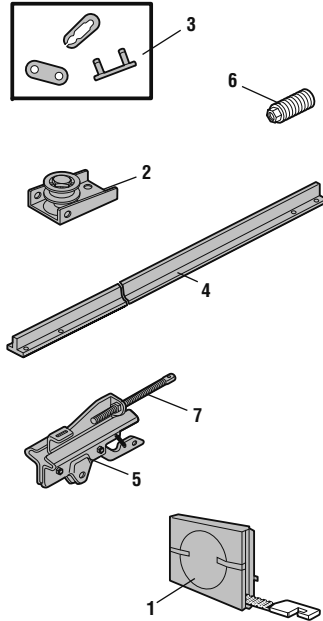

Installation Parts

Description	Part Number
1 Curved Door Arm	178B35
2 Door Bracket with Clevis Pin and Fastener	41A5047-1
3 Emergency Release Rope and Handle	41A2828
4 Header Bracket with Clevis Pin and Fastener	41A4353-1
5 Remote Control Visor Clip	29B137
6 Safety Sensor Bracket	41A5266-1
7 Safety Sensor Kit Receiving and sending sensors with 2-conductor wire	41A5034
8 Straight Door Arm	178B34
9 White and Red/White Wire	41B4494-1
10 3V2032 Lithium Battery	10A20
11 Remote Control	893RGX
12 Multi-function Door Control	041A7185-2

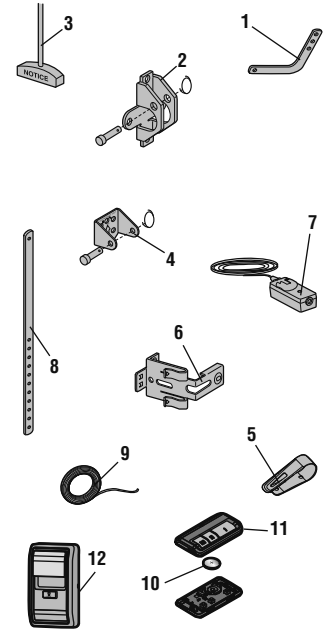

Repair Parts

Garage Door Opener Parts - MODEL 8355RGD

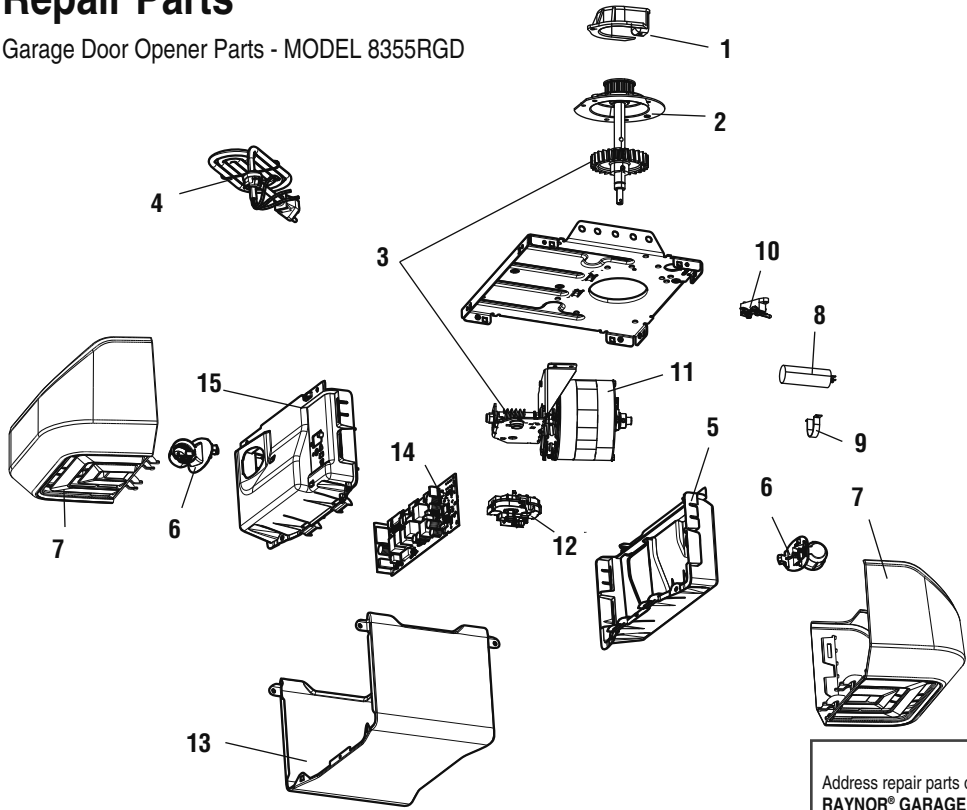

	Description	Part Number
1	Cover with Screws	41A4371
2	Gear and Sprocket	41A4885-5
3	Drive and Worm Gear	41A2817
4	Line Cord	41B4245
5	Front End Panel	41A7756
6	Light Socket	41C279
7	Light Lens	041A7562-1
8	Capacitor	30B532
9	Capacitor Bracket	12A373
10	Terminal Block	41A3150
11	Motor	41A7442
12	Travel Module	41D7742-7
13	Cover	041A7619-6
14	Logic Board	45ACT
15	Logic Board End Panel	41D216
	Not Shown	
	Dual Wire Harness Kit	41A7790

Contact Information

Address repair parts order to:
RAYNOR® GARAGE DOORS
 6050 S. Country Club Rd.
 Tucson, AZ 85706

For installation and service information call:
1-800-472-9667
 Or visit us online at:
www.raynor.com

Before calling, please have the model number of the garage door opener. If you are calling about a Troubleshooting issue, it is recommended that you have access to your garage door opener while calling. If you are ordering a repair part please have the following information: part number, part name, and model number.

